

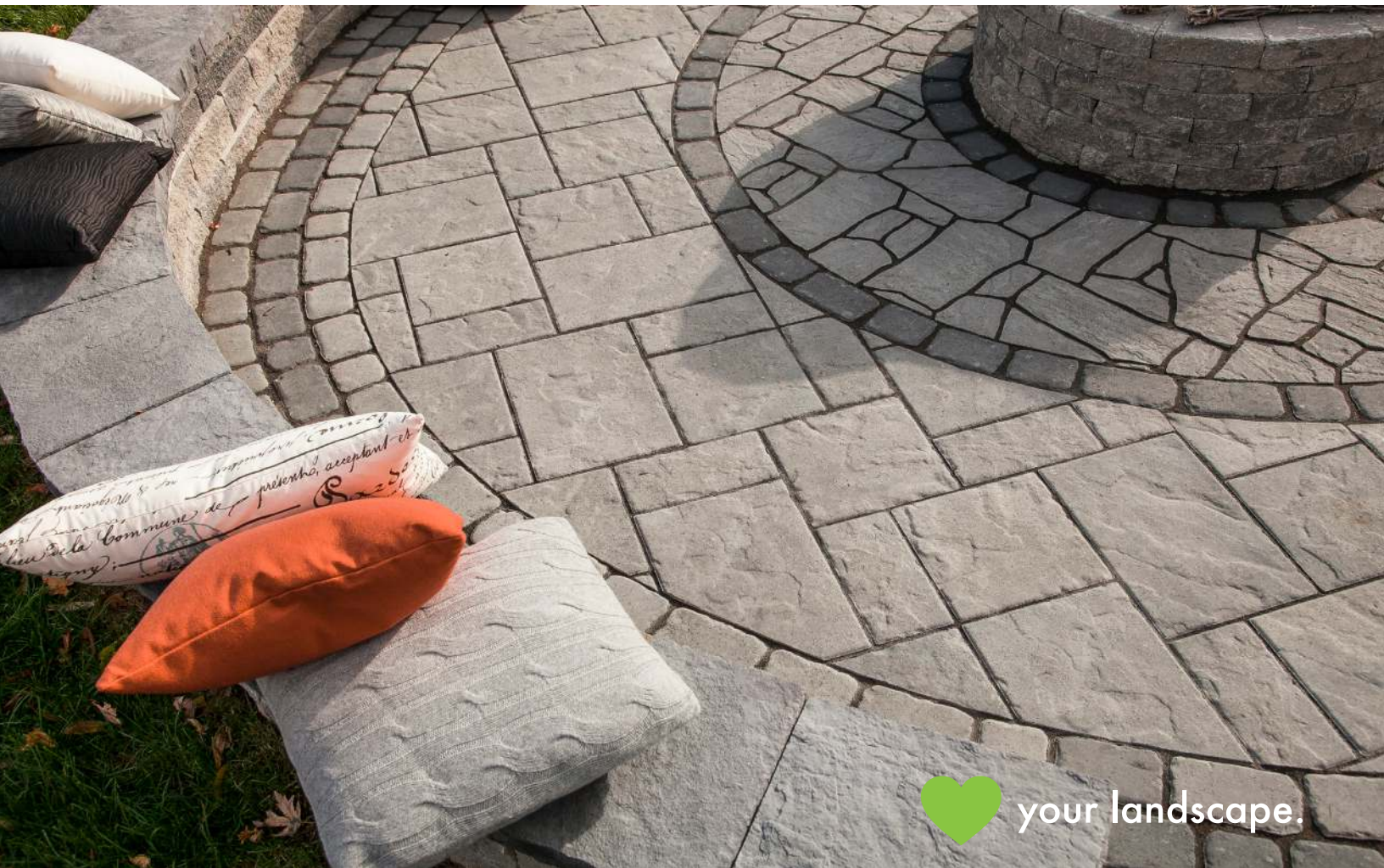

Toemar¹⁹⁷⁹

GARDEN SUPPLIES • FIREWOOD



 your landscape.

2018 PRICE LIST

Prices effective APRIL 1, 2018

Member of
landscapeontario.com
Green for Life!

Interlocking Pavers

CLASSIC LOOK	MEASUREMENTS			DETAILS	
	Thickness	Quick Dimensions ¹	Min. Purchase (Sq Ft)	Brochure Page Number	Price ² (per Sq Ft)
Standard	60 mm	4"x 8"	18 ft ²	BWS - 53	\$2.00
Double Standard	60 mm	8"x 8"	16 ft ²	BWS - 53	\$2.33
Villa Mix	60 mm	5"x5" 2.5"x5"	10 ft ²	BWS - 52	\$2.52
Villa Rectangle	60 mm	5"x7"	15 ft ²	BWS - 52	\$2.52
Galleria Mix	60 mm	6"x6" 3"x6"	12.15 ft ²	N/A	\$2.58
Galleria Rectangle	60 mm	6"x9"	20 ft ²	N/A	\$2.58
Handy Pavers	60 mm	12"x12"	1 ft ²	TRIPLEH - 10	\$2.39
TUMBLLED/ ANTIQUE FINISH					
Strada Nova or Antico	70 mm	(S) 4"x7" (M) 6"x7" (L) 8"x7" (J) 10"x14"	(S) 13 ft ² (M) 12 ft ² (L) 16 ft ² (J) 24 ft ²	BWS - 43	\$3.89
Adora Antico	60 mm	8"x11" 5"x11" 8"x5" 5"x5"	22 ft ²	N/A	\$3.75
Pathway	60 mm	5"x 8"	16.5 ft ²	N/A	\$3.90
English Cobble Mix	60 mm	3"x6" 6"x6" 6"x9"	12 ft ²	PERMA - 86	\$3.82
English Cobble Rectangle	60 mm	6"x9"	17 ft ²	PERMA - 86	\$3.82
Bellagio 285	70 mm	11"x8"	24 ft ²	BWS - 50	\$4.50
TEXTURED/IMPRESSED SURFACES					
Trevista 50 ³	50 mm	6.5"x13" 13"x13" 13"x19"	10.45 ft ²	BWS - 61	\$3.56 \$3.86 (PREM. COLOR)
Richmond 50 ³	50 mm	6.5"x13"	12.3 ft ²	BWS - 63	\$3.56
Birkdale	60 mm	5"x5" 5"x10" 10"x10" 10"x15"	12 ft ²	PERMA - 89	\$3.56
Eva	60 mm	8.75"x4.5" 8.75"x8.75" 8.75"x13.25"	12.04 ft ²	TECHO - 58	\$4.00
Blu 60 Slate ³	60 mm	6.5"x13" 13"x13" 13"x19"	10.62 ft ²	TECHO - 33	\$4.19

Note: All interlocking pavers are designed for both vehicular and pedestrian traffic, unless otherwise noted.

Interlocking Pavers

MEASUREMENTS			DETAILS	
Thickness	Quick Dimensions ¹	Min. Purchase (Sq Ft)	Brochure Page Number	Price ² (per Sq Ft)

TEXTURED/IMPRESSED SURFACES (CONTINUED)

Blu 60 Slate (Onyx Black) ³	60 mm	6.5"x13"	10.55 ft ²	TECHO - 33	\$4.92
Blu 80 Slate	80 mm	6.5"x13" 13"x13" 13"x19"	10.62 ft ²	TECHO - 55	\$5.50
Blu 80 Slate (Onyx Black)	80 mm	6.5x13"	10.55 ft ²	TECHO - 55	\$6.36
Kensington	80 mm	16.5"x10" 11"x11" 11"x5.5"	18 ft ²	PERMA - 76	\$3.84
Moderna	70 mm	16"x8/12"	8 ft ²	BWS - 47	\$4.75
Ardesia	70 mm	19.29"x10.41"	8 ft ²	BWS - 49	\$4.75
Trevista 80	80 mm	6.5"x13" 13"x13" 13"x19"	10.45 ft ²	BWS - 37	\$4.49 \$4.99 (PREM. COLOR)
Richmond 80	80 mm	6.5"x13"	12.3 ft ²	BWS - 39	\$4.99
Corso	70 mm	10"x5" 8"x5" 5"x5"	94 ft ²	BWS - 45	\$5.30

SMOOTH SURFACES

Trevista 50 Smooth ³	50 mm	6.5"x13" 13"x13" 13"x19"	10.45 ft ²	BWS - 59	\$3.56 \$3.86 (PREM. COLOR)
Adelaide 50 ³	50 mm	6.5"x13"	12.3 ft ²	BWS - 65	\$3.56
Carleton	60 mm	5"x5" 5"x10" 10"x10" 10"x15"	12 ft ²	PERMA - 84	\$3.56
Manhattan	80 mm	4.3" or 6.5" Widths	80 ft ²	BWS - 33	\$5.30
Trevista 80 Smooth	80 mm	6.5"x13" 13"x13" 13"x19"	10.45 ft ²	BWS - 35	\$4.99 \$5.49 (PREM. COLOR)
Adelaide 80	80 mm	6.5"x13"	12.3 ft ²	BWS - 41	\$4.99

Note: All interlocking pavers are designed for both vehicular and pedestrian traffic, unless otherwise noted
Premium color refers to Driftwood and Glacier Creek

¹ Quick Dimensions refer to a simple and rounded off imperial measurement, most Interlocking Pavers are metric in size - please refer to Brochure Page # for specific sizes.

² Pricing does NOT include delivery/shipping, please refer to delivery price guide.

³ Pedestrian Weight Only - Recommended for walkways and patios ONLY





DELIVERY GUIDE

LOCAL DELIVERY RATE
(4 skids or less)
\$115.00







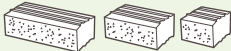
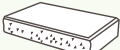

PRICE/SQUARE DELIVERY
(over 4 skids)
50mm & 60mm = \$0.24/ft,
70mm = \$0.26/ft
80mm = \$0.30/ft

Garden/Retaining Walls







HEAVY DUTY RETAINING WALLS

		MEASUREMENTS		DETAILS	
		Dimensions	Brochure Page Number	Aprox. Cost per LNFT	Price Per
Parkwall Regular		8"x6"x12"	BWS - 77	\$7.20	\$4.30
Parkwall Corner		8"x6"x12"	BWS - 77	\$11.60	\$9.99
Parkwall 24" Caps		24"x3"x12"	BWS - 77	\$4.20 \$4.50	\$8.40 \$8.99 (ULT. BLACK)
Barollo Caps		10"x3"x12.5"	BWS - 90	\$5.20	\$4.30

MEDIUM DUTY RETAINING WALLS

Garden Lock Triple Pack*		15"x5"x9" 10"x5"x9" 8"x5"x9"	BWS - 76	\$4.20	\$10.25 / ft ²
Garden Lock Coping		16"x3"x10.5"	BWS - 76	\$5.28	\$6.60
Garden Lock Wedge		8/5"x9"x5"	BWS - 76	\$4.91	\$2.75
Garden Lock Wedge Coping		8/5"x3"x10.5"	BWS - 76	\$6.64	\$2.99
Palladio Wedge		8/5"x9"x5"	BWS - 78	\$6.69	\$3.75
Palladio Wedge Coping		8/5"x3"x10.5"	BWS - 78	\$9.55	\$4.30
Hazelton Wall		12"x5"x9"	BWS - 74	\$5.99	\$5.99 \$6.75 (ULT. BLACK)
Hazelton Corners		13"x5"x7"	BWS - 74	\$7.50	\$7.50 \$8.50 (ULT. BLACK)
Montana Cap		22"x2"x10.5"	BWS - 88	\$13.10	\$24.00

LIGHT DUTY RETAINING WALLS

Wedgestone		9/6"x4"x8"	PERMA - 109	\$2.93	\$2.20
Wallstone Standard		12"x4"x8"	PERMA - 108	\$2.99	\$2.99
Wallstone Coping		12"x4"x8"	PERMA - 108	\$2.99	\$2.99
Antico Stacker		12"x4"x8"	BWS - 75	\$3.79	\$3.79
Dimensional Wall Wedge		12/8"x4x8"	N/A	\$6.10	\$4.99
Wedgerock		12/9"x4"x7"	TRIPLEH - 33	\$5.40	\$5.99
Wedgerock Corners		8"x4"x7" 13"x4"x13"	TRIPLEH - 33	\$6.36	\$8.99

Note: All images are not to scale and used for representational purposes only.

EXTRAS

FILTER CLOTH (4"x100')

\$65

ADHESIVE PREMIUM (300 mL)

\$7

FILTER CLOTH (5"x360')

\$199

ADHESIVE PREMIUM (850 mL)

\$13

4" WEEPING TILE (min. 10 ft)

\$1.49 / ft

BUTLE TAPE (20 ft roll)

\$7

Patio Stones

		MEASUREMENTS		DETAILS	PRICE				
		L x W x D (mm)		Colour	12 x 24	12 x 30	16 x 16	24 x 24	24 x 30
BUILDER GRADE									
BASKET WEAVE		40 (depth)	Off White	\$4.99	\$4.99	-	\$6.99	\$7.99	
WHITE BRICK PATTERN		40 (depth)	White	\$4.99	\$4.99	-	\$6.99	\$7.99	
STANDARD PRESS		40 (depth)	Grey, Red	\$4.99	\$4.99	\$3.99 \$3.99	\$6.99 \$7.99	\$7.99	
RAISED DIAMOND		40 (depth)	White	\$4.99	\$4.99	-	\$6.99	\$7.99	
STEP RISER (24" OR 30")		600/750 x 150 x 95	Grey	\$8.99	-	-	-	-	

		MEASUREMENTS	DETAILS	PRICE				
		Depth (mm)	Colour	12 x 30	16 x 16	16 x 24	24 x 24	20 x 20
ARCHITECTURAL TILES								
STONETILE™ TUSCANNI*		40	Sorrento, Cappuccino	-	\$6.86	\$10.30	\$15.42	-
EXPOSED AGGREGATE		40	Mystic Red, Ottawa, Alabama	-	-	-	-	\$8.99
TERRA STONE		40	Woodland Moss, Weathered Oak	-	-	-	\$8.75	-
COBBLE PATTERN		40	Red Range, Red	-	-	-	-	\$5.99
TRESCA		50	BM, GM, DW, GC	10 x 10 - \$3.36, 10 x 20 - \$5.80, 20 x 20 - \$10.75				
AVARI		50	GC, DW, ULT BLK, K	14 x 28 - \$6.55 / ft ² or \$18.14 / pc				
BAYSIDE		50	Granite, Conestoga	12 x 24 - \$7.12				
OMEGA		60	Granite, Conestoga	12 x 24 - \$7.65				

*While supplies last

DW = Driftwood, GC = Glacier Creek, GM = Grey Mix, K = Kashmir Blend, BM = Beige Mix

RECOMMENDED INSTALLATION DIAGRAM

Application	Crush Run or Screenings	Sand or Screenings
	Compacted Base	Final Grade (loose)
Patios & walks	4-6"	1"
Residential	6-12"	1"
Commercial	12-18"	1"

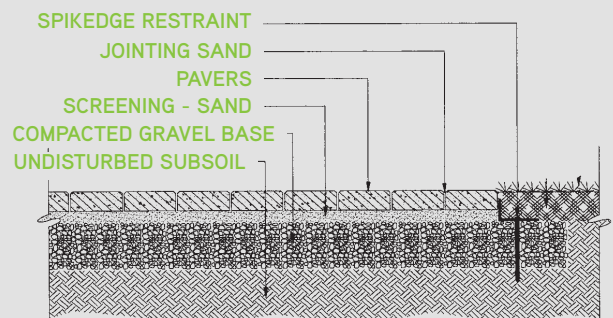

Natural Stones

BOULDERS AND ROCKS

	PRICE	
	Single	Bulk or Pallet
BLUE MOUNTAIN OVAL ROCK	\$0.19 / lb	\$299 / tn
ORILLIA LIMESTONE	\$0.18 / lb	\$299 / tn
BOBCAYGEON	\$0.18 / lb	\$299 / tn
QUARTZ, MARBLE CHUNKS, RIVER ROCK	\$0.30 / lb	\$0.28 / lb
SKIPPERS	\$0.55 / lb	\$0.50 / lb

FLAGSTONE (RANDOM)

	MEASUREMENTS	PRICE		
	Depth (in)	Under 400 lb (Single piece)	Over 400 lb	Pallet
WIARTON RANDOM CUT	1, 1.5, 2	\$0.25 / lb	\$0.23 / lb	\$0.20 / lb
WIARTON RANDOM CUT	3 or more	Special order		





FLAGSTONE SQUARE CUT

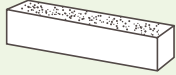

	DETAILS		PRICE	
	Sizes	Colour	Single	Pallet
NATURAL	12 x 24, 18 x 24, 24 x 24, 24 x 36	Slate Grey, Autumn Brown, Blue Ice, Limestone Black	\$6.49 / ft ²	\$6.16 / ft ²
FLAMED / BRUSHED	12 x 24, 18 x 24, 24 x 24, 24 x 36	Hampton Limestone	\$8.49 / ft ²	\$8.06 / ft ²
GRANITE	12 x 24, 18 x 24, 24 x 24	Jet Black, Algonquin Brown	\$8.99 / ft ²	\$8.54 / ft ²

OTHER

	DETAILS		PRICE	
	Sizes	Colour	Single	Pallet
TREAD COPINGS	12/16 x 72 x 2 12 x 48 x 2	Slate Grey, Autumn Brown, Blue Ice, Limestone Black	\$12.25 / ft ²	\$11.99 / ft ²
TREAD COPINGS GRANITE	12 x 72 x 2 12 x 48 x 2	Jet Black	\$17.99 / ft ²	\$17.09 / ft ²
TREAD COPING FLAMMED	12 x 72x 2 12 x 48 x 2	Hampton Limestone	\$14.99 / ft ²	\$14.25 / ft ²
TREAD COPINGS ACED WASHED	12 x 48 x 2	Algonquin Brown	\$15.50 / ft ²	\$14.73 / ft ²

Curbs & Edging

CURBS		MEASUREMENT	PRICE		
		L x W x D (mm)	Natural	Charcoal, Red	Beige Mix, Salmon Mix, Grey Mix
GARDEN		800 x 150 x 100	\$9.99	\$9.99	-
DRIVEWAY		1000 x 150 x 150	\$11.99	\$11.99	-
ANTIQUE**		450 x 150 x 150	-	-	\$8.15
ANTICO		400 x 150 x 100	-	-	\$4.99

SCALLOPED EDGE		MEASUREMENT	PRICE	
		H x L x D (in)	White	Red, Grey
STRAIGHT 9"*		9 x 24 x 2	\$3.99	-
CURVED 9"*		9 x 24 x 2	\$6.99	-

*While supplies last

PAVER EDGING	MEASUREMENT	PRICE
	Height (in)	
ALUMINUM	100	\$15
PLASTIC	96	\$14
PACK OF NAILS 10" (5)	-	\$2.50
	L x W x D (in)	
SPLIT EDGE	12 x 4 x 4	\$2.79

EXTRAS

SPLASH PAD (24 X 12) (600 x 275 x 80 mm)	\$9.99
STONE CUTTING	\$1 per 6 sq. inches
STANDARD CONCRETE BLOCK	
4" (7.5 x 15.35 x 4")	\$2.55
6" (7.5 x 15.35 x 6")	\$2.80
8" (7.5 x 15.35 x 8")	\$3.20
10" (7.5 x 15.35 x 10")	\$3.70



Visit us and also check out our **PLAN YOUR PROJECT** page for simple installation tips!

WWW.TOEMAR.CA

CHECK US OUT ON FACEBOOK,
PINTEREST, AND HOZZ



/toemargarden



/toemar



/toemargardensupplies

Steps

	MEASUREMENTS	DETAILS	PRICE
	L x W x D (mm)	Colour	
36" No. 1*	910 x 305 x 178	White	\$60
36" No. 2*	910 x 609.6 x 178	White	\$70
48" No. 1*	1215 x 305 x 178	White	\$70
48" No. 2*	1215 x 609.6 x 178	White	\$80
60" No. 1*	1520 x 305 x 178	White	\$80
60" No. 2*	1520 x 609.6 x 178	White	\$90
72" No. 1*	1825 x 305 x 178	White	\$90
72" No. 2*	1825 x 609.6 x 178	White	\$100
PLATFORMS (36")*	910 x 910 x 178	White	\$100
PLATFORMS (48")*	1215 x 910 x 178	White	\$120
STEP FILLERS 12* (Sold in pairs)	305 x 115 x 178	White	\$20
STEP FILLERS 24* (Sold in pairs)	610 x 135 x 178	White	\$40
CAMDEN STEP	1219 x 406 x 152	Sahara, Ultra Black	\$120
VALENTIA BLOCK (Filler)	325 x 100 x 175	Sandstone, Slate Brown, Sorrento	\$20
TERRACE STEP	1500 x 500 x 150	Sandstone, Slate Brown, Sorrento	\$168
VALENTIA (Solid)	1200 x 350 x 175	Sandstone, Slate Brown, Sorrento	\$138

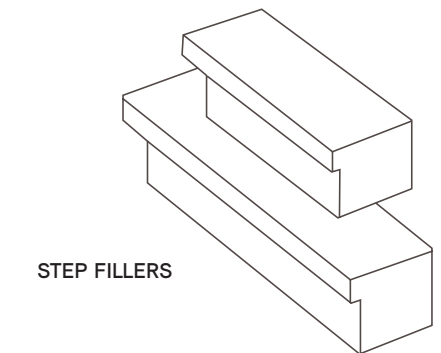
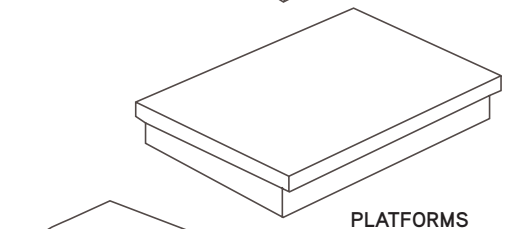
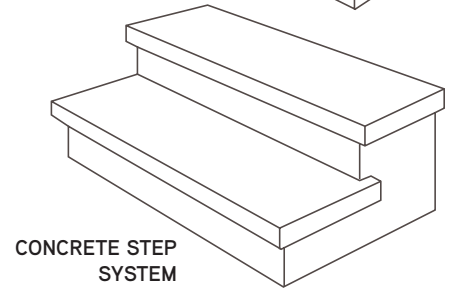
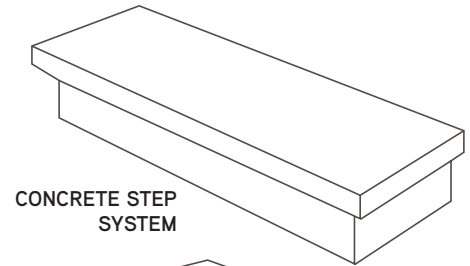

*Builder grade pre-cast steps

DELIVERY CHARGES – POLICIES & CONDITIONS

- Prices are subject to change without notice.
- Payment of material is required at the time of order (Visa, MasterCard, Debit or Cash).
- Cancelled pre-booked orders that have been paid using Visa, MasterCard or Debit will be subject to a 5% cancellation fee.
- Material calculation is the customer's responsibility; Toemar is not liable for a shortage of or additional material.
- All discrepancies, returns and/or changes to an order must be accompanied by an invoice. Discrepancies and/or damaged products must be reported within 24 hours upon delivery or pick up.
- No guarantee is given on exact product colour/pigment, surface texture, size, thicknesses or the effects of efflorescence.
- Skid products: Minimum \$115 delivery charge (interlocking pavers, patio stones, sod, natural stone, rocks, boulders, etc.) Extra fees are applied where orders are greater than 4 skids, delivery is outside local area, placement of rocks and boulders on private property, product requires an additional pallet for packaging reasons. Additional pallets incur a \$20 deposit, however it is customer responsibility to return

pallets.

- Bulk products: Minimum \$55.00 delivery charge. A \$35 split charge will be applied to orders requiring separation of two products. Handling fees will be applied if additional products are added to bulk orders; the fees will vary based on weight.
- For every skid that requires alteration/customization a \$10 split charge will be applied.
- All products delivered will be placed on the curb line and/or boulevard. Toemar staff will have final say on drop location. Toemar is not responsible for any property damage if permission is granted to deliver on the private property.
- A 25% re-stocking charge is applied to all returned products that are not damaged and/or defective.
- Orders that have been delivered and cancelled by customer are subject to a pick up charge of \$115 (local area price only, prices subject to increase in accordance to distance) plus the applicable re-stocking fees. Skids are required to be in original condition, if skid(s) require re-packing then additional fees will apply.
- Bin rentals are charged for soil/dirt only. Extra fees are applied to additional materials added to the soil/dirt bin.
- Bin rentals used for renovation waste (such as wood or drywall) are charged according to weight. A \$185 flat rate fee will be applied to the bin. Bin contents will be charged at \$99 per metric ton. A credit card must be given.

Drainage Systems

HEXALINE	LENGTH	COLOUR	PRICE
CHANNEL WITH GRATE	1 m	Black, Grey	\$45
CHANNEL WITH GALVANIZED GRATE	1 m	Grey	\$45
CORNER UNIT	1 m	Black, Grey	\$29
ACCESSORY PACK	1 m	Black, Grey	\$19

Cleaners & Sealers

	SIZE	PRICE
SEALER (OIL BASE)	1 gallon	\$40
SEALER (OIL BASE)	5 gallon	\$165
EFFLORESCENCE CLEANER	64 oz	\$22
OIL OFF	28 oz	\$20
GREASE RELEASE	32 oz	\$20
SEAL GRIP	32 oz	\$20
PUMP SPRAYER	3.5 gal	\$179.99
SEALER (NATURAL STONE)	1 qt	\$35
SEALER (NATURAL STONE)	1 gal	\$75

EXTRAS

Did you know that you can save money, time and effort by renting professional grade tools instead of buying them?

Toemar has a wide selection of quality hand and power tools available for you to complete your landscaping project just like the professionals do.

Contact us today to find out what we carry!

LED Paver Lighting Systems

	PRICE
PAVER - DECK DOT 4 PACK	\$99
8 PAVER - DECK DOT LIGHTS (SET)	\$335
36 WATT TRANSFORMER	\$139
60 WATT TRANSFORMER	\$199
100 WATT TRANSFORMER	\$279
RADIANCE LANDSCAPE LIGHT* (Post or Bracket)	\$105
BIG MAX BLOCK LIGHT*	\$89
100 FT LOW VOLTAGE WIRE	\$39
DIMMER WITH REMOTE	\$80

* 4 colors available

POWER EFFICIENCY SPECS

Paver dot = 0.75 watts (each)

Radiance or Big Max = 1.9 watts (each)

Luna Paver = 1.4 watts (each)

Sets include: power supply, timer, gel caps, forstner drill bit and 8 dots.

Bagged Products

SOILS & MULCH

	SIZE	PRICE
3-WAY MIX	30 L	\$3.39
TOP SOIL	30 L	\$3.39
BLACK EARTH	30 L	\$3.39
POTTING SOIL	15 L	\$5
SHEEP / CATTLE MANURE COMPOST	18 kg	\$5
100% REAL CATTLE MANURE	30 L	\$5
PEAT MOSS	2.2 ft ³	\$8
PEAT MOSS	3.8 ft ³	\$10
CEDAR / HEMP MULCH	2 ft ³	\$7.99
BARK NUGGETS	2 ft ³	\$7.99
RED CEDAR MULCH	2 ft ³	\$7.99
BLACK CEDAR MULCH	2 ft ³	\$7.99
LANDSCAPE FABRIC	3' x 25'	\$13
LANDSCAPE FABRIC	3' x 50'	\$17
LANDSCAPE FABRIC	4' x 50'	\$22
LANDSCAPE FABRIC	4' x 100'	\$38
LANDSCAPE FABRIC	4' x 150'	\$55

DECORATIVE ROCK

WHITE MARBLE (1" OR ¾")	18 kg	\$6
RIVER ROCK 1", 1-3"	18 kg	\$6
RIVER ROCK 4-8"	30 kg	\$12
RED BRICK	30 L	\$7
GOLD PEBBLE	18 kg	\$12

GRASS SEED

QUICK SUN / SHADE	1 kg	\$10
QUICK SUN / SHADE	2 kg	\$18
QUICK SUN / SHADE	5 lb	\$40
STARTER FERTILIZER	2 kg	\$10

FIREWOOD

	SIZE	PRICE
FIREWOOD BAGS	0.75 ft ²	\$10
KINDLING BAGS	0.3 ft ³	\$6
¼ FACE CORD	8 ft ³	\$55
½ FACE CORD	16 ft ³	\$90
1 FACE CORD	32 ft ³	\$140*

AGGREGATES

LIMESTONE SCREENINGS	30 L	\$4.25
CRUSH RUN	30 L	\$5
¾ CLEAR GRAVEL	30 L	\$4.25
COARSE SAND	30 L	\$5
FINE SAND	30 L	\$5
⅜ PEA GRAVEL	30 L	\$5.50
HPB	30 L	\$5.50

INTERLOCKING SAND

JOINTING SAND	20 kg	\$6
POLYMERIC SAND RJ BROWN	22 kg	\$22
POLYMERIC SAND RJ GREY	22 kg	\$22
POLYMERIC SAND RJ JET BLACK	22 kg	\$30
POLYMERIC SAND WJ	22 kg	\$30

CONCRETE / CEMENT

STONE MIX	30 kg	\$5.65
SAND MIX	30 kg	\$6.65
PORTLAND	30 kg	\$15.99
MORTAR MIX	40 kg	\$6.99
MORTAR TYPE S	33 kg	\$14
MODIFIED MORTAR	20 kg	\$25

*Local firewood delivery \$55

Bulk Products

	VEGGIE/ OVERSEED SOIL	TOP SOIL	CATTLE MANURE	BROWN MULCH	RED/BLACK MULCH	LIMESTONE SCREENING	CRUSH RUN GRAVEL	SAND/ GRAVEL	HPB/PEA GRAVEL	1-3" POTATO STONE	1-3" RIVER STONE	3-5" RIVER STONE
1 CU. YD.	\$105	\$78	\$105	\$100	\$111	\$93	\$96	\$105	\$104	\$131	\$173	\$178
2 CU. YD.	\$153	\$101	\$153	\$145	\$167	\$131	\$137	\$155	\$153	\$207	\$291	\$301
3 CU. YD.	\$201	\$124	\$201	\$190	\$223	\$169	\$178	\$205	\$202	\$283	\$409	\$424
4 CU. YD.	\$249	\$147	\$249	\$235	\$279	\$207	\$219	\$255	\$251	\$359	\$527	\$547
5 CU. YD.	\$297	\$170	\$297	\$280	\$335	\$245	\$260	\$305	\$300	\$435	\$645	\$670
6 CU. YD.	\$345	\$193	\$345	\$325	\$391	\$283	\$301	\$355	\$349	\$511	\$763	\$793
7 CU. YD.	\$393	\$216	\$393	\$370	\$447	\$321	\$342	\$405	\$398	\$587	\$881	\$916
8 CU. YD.	\$441	\$239	\$441	\$415	\$503	\$359	\$383	\$455	\$447	\$663	\$999	\$1039

PRO TIP

VEGGIE SOIL

is a clay-free mixture of peat loam, sand loam, compost and manure

Excellent for:

- New Flower and Vegetable Beds
- Top Dressing Existing Gardens
- Mixing in Composter

TOP SOIL

is best used for grading or filling uneven ground

MULCH

is an organic ground cover, to beautify and protect root systems from frost and drought.

LIMESTONE SCREENINGS

is most commonly used as base for interlocking pavers and patio stones

QUICK METHOD TO CALCULATE HOW MUCH YOU NEED, BY THE YARD

- Works with Topsoil, Sand, Gravel, etc.
- Allow 10% for settling

Using tape measure, multiply...

$$\text{LENGTH (FEET)} \times \text{WIDTH (FEET)} \times \text{DEPTH (INCHES)} = \text{_____} \div 300 = \text{_____ YARDS}$$

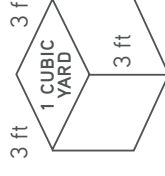

- One Cubic Yard is 7 wheelbarrow (4 cu.ft.) or 27 bags (1 cubic foot or 28 litres)

BIN RENTAL SIZES

4 yard \$199 8 yard \$299 12 yard \$399 25 yard* \$185

Rental term: 4 days. \$40 for every additional day. *Renovation waste only:

Base plus \$99 per ton (2 ton minimum)



MY WORKSHEET

Before you make your order, here's a handy checklist to make sure you have all the information you need:

-
-
-
-
-
-
-
-



/toemargardensupplies



/toemargarden



/toemar



Toemar¹⁹⁷⁹
GARDEN SUPPLIES • FIREWOOD

1005 Eglinton Ave. W., Mississauga, ON L5V 1R7
905-826-3821

www.toemar.ca