



# 2019 PRICE LIST

Prices effective APRIL 1, 2019

# Interlocking Pavers

CLASSIC LOOK	MEASUREMENTS			DETAILS	
	Thickness	Quick Dimensions <sup>1</sup>	Min. Purchase (Sq Ft)	Brochure Page Number	Price <sup>2</sup> (per Sq Ft)
Standard	60 mm	4"x 8"	18 ft <sup>2</sup>	BWS - 53	\$2.05
Double Standard	60 mm	8"x 8"	16 ft <sup>2</sup>	BWS - 53	\$2.39
Villa Mix	60 mm	5"x5" 2.5"x5"	10 ft <sup>2</sup>	BWS - 52	\$2.55
Villa Rectangle	60 mm	5"x7"	15 ft <sup>2</sup>	BWS - 52	\$2.55
Galleria Mix (Limited Supplies Available)	60 mm	6"x6" 3"x6"	12.15 ft <sup>2</sup>	N/A	\$2.58
Galleria Rectangle (Limited Supplies Available)	60 mm	6"x9"	20 ft <sup>2</sup>	N/A	\$2.58
Handy Pavers	60 mm	12"x12"	1 ft <sup>2</sup>	TRIPLEH - 10	\$2.39

## TUMBLLED/ ANTIQUE FINISH

Strada	70 mm	(S) 4"x7" (M) 6"x7" (L) 8"x7" (J) 10"x14"	(S) 13 ft <sup>2</sup> (M) 12 ft <sup>2</sup> (L) 16 ft <sup>2</sup> (J) 24 ft <sup>2</sup>	BWS - 43	\$3.89 (Nova) \$4.00 (Antico)
Adora Antico (Limited Supplies Available)	60 mm	8"x11" 5"x11" 8"x5" 5"x5"	22 ft <sup>2</sup>	N/A	\$3.75
Pathway (Limited Supplies Available)	60 mm	5"x 8"	16.5 ft <sup>2</sup>	N/A	\$3.75
English Cobble Mix	60 mm	3"x6" 6"x6" 6"x9"	12 ft <sup>2</sup>	PERMA - 87	\$3.82
English Cobble Rectangle	60 mm	6"x9"	17 ft <sup>2</sup>	PERMA - 87	\$3.82
Bellagio 285	70 mm	11"x8"	24 ft <sup>2</sup>	BWS - 50	\$4.50

## TEXTURED/IMPRESSED SURFACES

Trevista 50 <sup>3</sup>	50 mm	6.5"x13" 13"x13" 13"x19"	10.45 ft <sup>2</sup>	BWS - 61	\$3.80 \$3.99 (PREM. COLOR)
Richmond 50 <sup>3</sup>	50 mm	6.5"x13"	12.3 ft <sup>2</sup>	BWS - 63	\$3.80
Birkdale	60 mm	5"x5" 5"x10" 10"x10" 10"x15"	12 ft <sup>2</sup>	PERMA - 86	\$3.60
Eva	60 mm	8.75"x4.5" 8.75"x8.75" 8.75"x13.25"	12.04 ft <sup>2</sup>	TECHO - 76	\$4.18
Blu 60 Slate <sup>3</sup>	60 mm	6.5"x13" 13"x13" 13"x19"	10.62 ft <sup>2</sup>	TECHO - 47	\$4.30

Note: All interlocking pavers are designed for both vehicular and pedestrian traffic, unless otherwise noted.

# Interlocking Pavers



MEASUREMENTS			DETAILS	
Thickness	Quick Dimensions <sup>1</sup>	Min. Purchase (Sq Ft)	Brochure Page Number	Price <sup>2</sup> (per Sq Ft)

## TEXTURED/IMPRESSED SURFACES (CONTINUED)

Blu 60 Slate (premium) <sup>3</sup>	60 mm	6.5"x13"	10.55 ft <sup>2</sup>	TECHO - 47	\$5.05
Blu 80 Slate	80 mm	6.5"x13" 13"x13" 13"x19"	10.62 ft <sup>2</sup>	TECHO - 75	\$5.63
Blu 80 Slate (premium)	80 mm	6.5x13"	10.55 ft <sup>2</sup>	TECHO - 75	\$6.49
Kensington	80 mm	16.5"x10" 11"x11" 11"x5.5"	18 ft <sup>2</sup>	PERMA - 83	\$3.90
Moderna	70 mm	16"x8/12"	8 ft <sup>2</sup>	BWS - 47	\$4.75
Ardesia	70 mm	19.29"x10.41"	8 ft <sup>2</sup>	BWS - 49	\$4.75
Trevista 80	80 mm	6.5"x13" 13"x13" 13"x19"	10.45 ft <sup>2</sup>	BWS - 37	\$4.55 \$4.99 (PREM. COLOR)
Richmond 80	80 mm	6.5"x13"	12.3 ft <sup>2</sup>	BWS - 39	\$4.99
Corso	70 mm	10"x5" 8"x5" 5"x5"	94 ft <sup>2</sup>	BWS - 45	\$5.30

## SMOOTH SURFACES

Trevista 50 Smooth <sup>3</sup>	50 mm	6.5"x13" 13"x13" 13"x19"	10.45 ft <sup>2</sup>	BWS - 59	\$3.80 \$3.99 (PREM. COLOR)
Adelaide 50 <sup>3</sup>	50 mm	6.5"x13"	12.3 ft <sup>2</sup>	BWS - 65	\$3.80
Carleton	60 mm	5"x5" 5"x10" 10"x10" 10"x15"	12 ft <sup>2</sup>	PERMA - 86	\$3.60
Manhattan	80 mm	4.3" or 6.5" Widths	80 ft <sup>2</sup>	BWS - 33	\$5.30
Trevista 80 Smooth	80 mm	6.5"x13" 13"x13" 13"x19"	10.45 ft <sup>2</sup>	BWS - 35	\$4.99 \$5.49 (PREM. COLOR)
Adelaide 80	80 mm	6.5"x13"	12.3 ft <sup>2</sup>	BWS - 41	\$4.99

Note: All interlocking pavers are designed for both vehicular and pedestrian traffic, unless otherwise noted  
Premium color refers to Driftwood and Glacier Creek

<sup>1</sup> Quick Dimensions refer to a simple and rounded off imperial measurement, most Interlocking Pavers are metric in size - please refer to Brochure Page # for specific sizes.

<sup>2</sup> Pricing does NOT include delivery/shipping, please refer to delivery price guide.

<sup>3</sup> Pedestrian Weight Only - Recommended for walkways and patios ONLY





### DELIVERY GUIDE

**LOCAL DELIVERY RATE**  
(4 skids or less)  
\$120.00







**PRICE/SQUARE DELIVERY**  
(over 4 skids)  
50mm & 60mm = \$0.24/ft,  
70mm = \$0.26/ft  
80mm = \$0.30/ft

# Garden/Retaining Walls

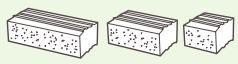
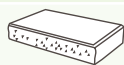





## HEAVY DUTY RETAINING WALLS

		MEASUREMENTS		DETAILS	
		Dimensions	Brochure Page Number	Aprox. Cost per LNFT	Price Per
Parkwall Regular		8"x6"x12"	BWS - 79	\$6.50	\$4.40
Parkwall Corner		8"x6"x12"	BWS - 79	\$11.60	\$9.99
Parkwall 24" Caps		24"x3"x12"	BWS - 79	\$4.25 \$5.30	\$8.50 \$8.99 (ULT. BLACK)
Barollo Caps		10"x3"x12.5"	BWS - 94	\$5.30	\$4.40

## MEDIUM DUTY RETAINING WALLS

Garden Lock Triple Pack*		15"x5"x9" 10"x5"x9" 8"x5"x9"	BWS - 78	\$4.42	\$10.45 / ft <sup>2</sup>
Garden Lock Coping		16"x3"x10.5"	BWS - 78	\$5.36 \$5.60	\$6.70 \$7.00 (ULT. BLACK)
Garden Lock Wedge		8/5"x9"x5"	BWS - 78	\$5.50	\$2.79
Garden Lock Wedge Coping		8/5"x3"x10.5"	BWS - 78	\$6.00	\$2.99
Garden Lock Corner		10"x5"x9"	BWS - 78	\$8.00	\$8.12
Hazelton Wall		12"x5"x9"	BWS - 76	\$5.99	\$5.99 \$6.75 (ULT. BLACK)
Hazelton Corners		13"x5"x7"	BWS - 76	\$7.50	\$7.50 \$8.50 (ULT. BLACK)
Montana Cap		22"x2"x10.5"	BWS - 92	\$13.50	\$25.00

## LIGHT DUTY RETAINING WALLS

Wedgestone		9/6"x4"x8"	PERMA - 101	\$3.60	\$2.29
Wallstone Standard		12"x4"x8"	PERMA - 101	\$3.10	\$3.10
Wallstone Coping		12"x4"x8"	PERMA - 101	\$3.10	\$3.10
Antico Stacker		12"x4"x8"	BWS - 77	\$3.89	\$3.89
Dimensional Wall Wedge		12/8"x4x8"	N/A	\$9.90	\$5.50
Wedgerock		12/9"x4"x7"	TRIPLEH - 33	\$10.00	\$5.99
Wedgerock Corners		8"x4"x7" 13"x4"x13"	TRIPLEH - 33	\$10.27	\$8.99

Note: All images are not to scale and used for representational purposes only.

### EXTRAS

FILTER CLOTH (4"x100')

\$65

ADHESIVE PREMIUM (300 mL) \$7

FILTER CLOTH (5"x360')

\$199

ADHESIVE PREMIUM (850 mL) \$13

4" WEEPING TILE (min. 10 ft) \$1.49 / ft

BUTLE TAPE (20 ft roll) \$7

# Patio Stones



		MEASUREMENTS	DETAILS	PRICE					
		L x W x D (mm)	Colour	12 x 24	12 x 30	16 x 16	24 x 24	24 x 30	
<b>BUILDER GRADE</b>									
BASKET WEAVE		40 (depth)	Off White	-	-	-	\$7.50	\$8.50	
WHITE BRICK PATTERN		40 (depth)	White	\$5.99	\$5.99	-	\$7.50	\$8.50	
STANDARD PRESS		40 (depth)	Grey, Red	-	-	\$3.99 \$3.99	\$7.50 \$7.99	\$8.50	
RAISED DIAMOND		40 (depth)	White	\$5.99	\$5.99	-	\$7.50	\$8.50	
STEP RISER (24" OR 30")		600/750 x 150 x 95	Grey	\$8.99	-	-	-	-	

		MEASUREMENTS	DETAILS	PRICE				
		Depth (mm)	Colour	12 x 30	16 x 16	16 x 24	24 x 24	20 x 20
<b>ARCHITECTURAL TILES</b>								
TERRA STONE		40	Woodland Moss, Weathered Oak	-	-	-	\$8.99	-
EXPOSED AGGREGATE		40	Ottawa, Mystic Red	-	-	-	-	\$8.99
COBBLE PATTERN		40	Red Range, Red	-	-	-	-	\$5.99
TRESCA		50	BM, GM, DW, GC	10 x 10 - \$3.39, 10 x 20 - \$5.80, 20 x 20 - \$10.75				
AVARI		50	GC, DW, ULT BLK, K	14 x 28 - \$5.99 / ft <sup>2</sup> or \$10.48 / pc				
BAYSIDE*		50	Granite, Conestoga	12 x 24 - \$6.99				
OMEGA*		60	Granite, Conestoga	12 x 24 - \$6.99				

\*While supplies last

DW = Driftwood, GC = Glacier Creek, GM = Grey Mix, K = Kashmir Blend, BM = Beige Mix

## RECOMMENDED INSTALLATION DIAGRAM

Application	Crush Run or Screenings	Sand or Screenings
	Compacted Base	Final Grade (loose)
Patios & walks	4-6"	1"
Residential	6-12"	1"
Commercial	12-18"	1"

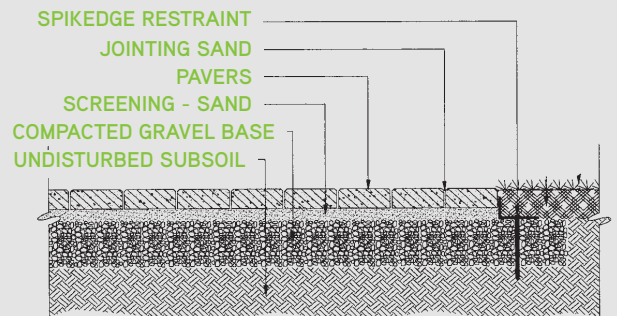

# Natural Stones

## BOULDERS AND ROCKS

	PRICE	
	Single	Bulk or Pallet
BLUE MOUNTAIN OVAL ROCK	\$0.19 / lb	\$299 / tn
ORILLIA LIMESTONE	\$0.18 / lb	\$299 / tn
BOBCAYGEON	\$0.18 / lb	\$299 / tn
QUARTZ, MARBLE CHUNKS, RIVER ROCK	\$0.30 / lb	\$0.28 / lb
SKIPPERS	\$0.55 / lb	\$0.50 / lb

## FLAGSTONE (RANDOM)

	MEASUREMENTS	PRICE		
	Depth (in)	Under 400 lb (Single piece)	Over 400 lb	Pallet
WIARTON RANDOM CUT	1, 1.5, 2	\$0.25 / lb	\$0.23 / lb	\$0.20 / lb
WIARTON RANDOM CUT	3 or more	Special order		

## FLAGSTONE SQUARE CUT

	DETAILS		PRICE	
	Sizes	Colour	Single	Pallet
NATURAL	12 x 24, 18 x 24, 24 x 24, 24 x 36	Slate Grey, Autumn Brown, Blue Ice, Limestone Black	\$6.49 / ft <sup>2</sup>	\$6.16 / ft <sup>2</sup>
FLAMED / BRUSHED	12 x 24, 18 x 24, 24 x 24, 24 x 36	Hampton Limestone	\$8.49 / ft <sup>2</sup>	\$8.06 / ft <sup>2</sup>
GRANITE	12 x 24, 18 x 24, 24 x 24	Midnight Black	\$8.99 / ft <sup>2</sup>	\$8.54 / ft <sup>2</sup>





## COPINGS

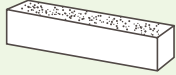

	DETAILS		PRICE	
	Sizes	Colour	Single	Pallet
TREAD COPINGS	12/16 x 72 x 2 12 x 48 x 2	Slate Grey, Autumn Brown, Blue Ice, Limestone Black	\$12.99 / ft <sup>2</sup>	\$12.25 / ft <sup>2</sup>
TREAD COPINGS GRANITE	12 x 72 x 2 12 x 48 x 2	Midnight Black	\$17.99 / ft <sup>2</sup>	\$17.09 / ft <sup>2</sup>
TREAD COPING FLAMMED	12 x 72 x 2 12 x 48 x 2	Hampton Limestone	\$15.50 / ft <sup>2</sup>	\$14.75 / ft <sup>2</sup>
TREAD COPING (Rebated)*	12 x 48 x 2	Slate Grey, Blue Ice Hampton Limestone	\$14.69 / ft <sup>2</sup> \$16.95 / ft <sup>2</sup>	\$14.15 / ft <sup>2</sup> \$16.15 / ft <sup>2</sup>
TREAD COPING (Straight Edged)	12 x 48 x 2	Slate Grey, Blue Ice	\$18.59 / ft <sup>2</sup>	\$17.87 / ft <sup>2</sup>

\*Hampton Limestone pricing is on the same line adjacent

# Curbs & Edging



CURBS		MEASUREMENT	PRICE		
		L x W x D (mm)	Natural	Charcoal, Red	Beige Mix, Salmon Mix, Grey Mix
GARDEN		800 x 150 x 100	\$9.99	\$9.99	-
DRIVEWAY		1000 x 150 x 150	\$12.50	\$12.50	-
ANTIQUE**		450 x 150 x 150	-	-	\$8.15
ANTICO		400 x 150 x 100	-	-	\$4.99

SCALLOPED EDGE		MEASUREMENT	PRICE	
		H x L x D (in)	White	Red, Grey
STRAIGHT 9"*		9 x 24 x 2	\$3.99	-
CURVED 9"*		9 x 24 x 2	\$6.99	-

PAVER EDGING	MEASUREMENT	PRICE
	Height (in)	
ALUMINUM	100	\$15
PLASTIC	96	\$14
PACK OF NAILS 10" (5)	-	\$2.50
	L x W x D (in)	
SPLIT EDGE	12 x 4 x 4	\$2.79

## EXTRAS

SPLASH PAD (24 X 12) (600 x 275 x 80 mm)	\$9.99
STONE CUTTING	\$1 per 6 sq. inches
STANDARD CONCRETE BLOCK	
4" (7.5 x 15.35 x 4")	\$2.55
6" (7.5 x 15.35 x 6")	\$2.80
8" (7.5 x 15.35 x 8")	\$3.20
10" (7.5 x 15.35 x 10")	\$3.70



Visit us and also check out our **PLAN YOUR PROJECT** page for simple installation tips!

[WWW.TOEMAR.CA](http://WWW.TOEMAR.CA)

CHECK US OUT ON FACEBOOK, PINTEREST, AND HOZZ



/toemargarden



/toemar



/toemargardensupplies

# Steps

	MEASUREMENTS	DETAILS	PRICE
	L x W x D (in)	Colour	
36" No. 1*	36 x 12 x 7	White	\$65
36" No. 2*	36 x 24 x 7	White	\$75
48" No. 1*	48 x 12 x 7	White	\$75
48" No. 2*	48 x 24 x 7	White	\$85
60" No. 1*	60 x 12 x 7	White	\$85
60" No. 2*	60 x 24 x 7	White	\$95
72" No. 1*	72 x 12 x 7	White	\$95
72" No. 2*	72 x 24 x 7	White	\$105
Platforms (36")*	36 x 36 x 7	White	\$105
Platforms (48")*	36 x 48 x 7	White	\$125
Step Fillers 12* <small>(Sold in pairs)</small>	4 x 7 x 12	White	\$20
Step Fillers 24* <small>(Sold in pairs)</small>	4 x 7 x 24	White	\$40
Camden Step	48 x 16 x 6	Sahara, Ultra Black	\$125
Camden Step 28" <small>(Filler)</small>	28 x 7 x 6	Sahara, Ultra Black	\$32
Camden Step 14" <small>(Filler)</small>	14 x 7 x 6	Sahara, Ultra Black	\$16
Valentia Block <small>(Filler)</small>	13 x 7 x 4	Sandstone, Slate Brown, Sorrento	\$22
Valentia <small>(Solid)</small>	48 x 14 x 7	Sandstone, Slate Brown, Sorrento	\$140
Terrace Step	60 x 20 x 6	Sandstone, Slate Brown, Sorrento	\$170
Raffinato	42 x 14.25 x 7	Onyx Black, Greyed Nickel, Beige Cream	\$76.21
Raffinato <small>(Filler)</small>	14.25 x 10 x 7	Onyx Black, Greyed Nickel, Beige Cream	\$21.95
Maya Step	48 x 32 x 6	Riviera, Rock Garden Brown, Baja Beige	\$262.15
Natural Stone - Solid	48/60/72 x 16 x 7	Slate Grey, Limestone Black, Autumn Brown, Hampton Limestone	\$42 / ft <sup>2</sup> \$54 / ft <sup>2</sup>
Natural Stone - Hollow	48 x 16 x 7	Slate Grey, Blue Ice	\$260

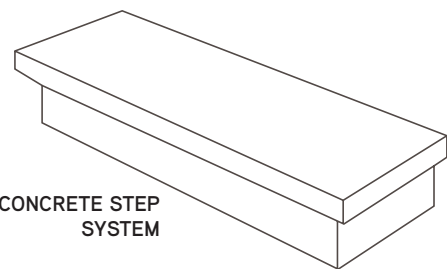

CONCRETE STEP SYSTEM

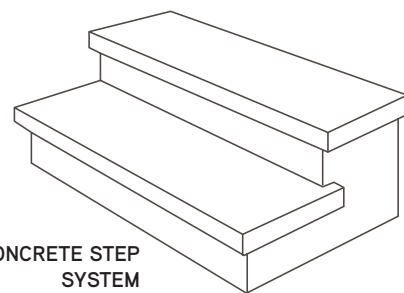

CONCRETE STEP SYSTEM

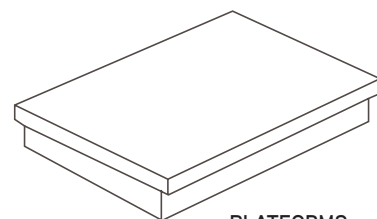

PLATFORMS



VALENTIA STEP

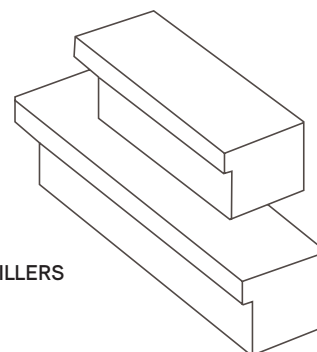

STEP FILLERS

\*Builder grade pre-cast steps



# Drainage Systems

ACO HEXALINE	LENGTH	COLOUR	PRICE
CHANNEL (Plastic)	1 m	Black	\$21
GRATE (Plastic or Galvanized)	1 m	Grey, Black	\$17
CORNER UNIT	1 m	Black	\$29
ACCESSORY PACK	1 m	Black	\$20

# Cleaners & Sealers

	SIZE	PRICE
SEALER (OIL BASE)	1 gallon	\$40
SEALER (OIL BASE)	5 gallon	\$170
EFFLORESCENCE CLEANER	64 oz	\$22
OIL OFF	28 oz	\$22
GREASE RELEASE	32 oz	\$22
SEAL GRIP	32 oz	\$22
PUMP SPRAYER	3.5 gal	\$179.99
SEALER (NATURAL STONE)	1 qt	\$40
SEALER (NATURAL STONE)	1 gal	\$80

# LED Paver Lighting Systems



	PRICE
PAVER - DECK DOT 4 PACK	\$99
8 PAVER - DECK DOT LIGHTS (SET)	\$335
36 WATT TRANSFORMER	\$139
60 WATT TRANSFORMER	\$199
100 WATT TRANSFORMER	\$279
RADIANCE LANDSCAPE LIGHT* (Post or Bracket)	\$105
BIG MAX BLOCK LIGHT*	\$89
100 FT LOW VOLTAGE WIRE	\$39
DIMMER WITH REMOTE	\$80

\* 4 colors available

# Tool Rentals

	4 HOURS	24 HOURS
COMPACTOR	\$45	65
MUCK TRUCK	\$65	\$105
SAW	\$65	\$105
HAND TAMPER	\$8	\$15

\*More tools available. See staff or visit toemar.ca for more details.

## DELIVERY CHARGES – POLICIES & CONDITIONS

- Prices are subject to change without notice.
- Payment of material is required at the time of order (Visa, MasterCard, Debit or Cash).
- Cancelled pre-booked orders that have been paid using Visa, MasterCard or Debit will be subject to a 5% cancellation fee.
- Material calculation is the customer's responsibility; Toemar is not liable for a shortage of or additional material.
- All discrepancies, returns and/or changes to an order must be accompanied by an invoice. Discrepancies and/or damaged products must be reported within 24 hours upon delivery or pick up.
- No guarantee is given on exact product colour/pigment, surface texture, size, thicknesses or the effects of efflorescence.
- Skid products: Minimum \$120 delivery charge (interlocking pavers, patio stones, sod, natural stone, rocks, boulders, etc.) Extra fees are applied where orders are greater than 4 skids, delivery is outside local area, placement of rocks and boulders on private property, product requires an additional pallet for packaging reasons. Additional pallets incur a \$20 deposit, however it is customer responsibility to return

pallets.

- Bulk products: Minimum \$65.00 delivery charge. A \$35 split charge will be applied to orders requiring separation of two products. Handling fees will be applied if additional products are added to bulk orders; the fees will vary based on weight.
- For every skid that requires alteration/customization a \$10 split charge will be applied.
- All products delivered will be placed on the curb line and/or boulevard. Toemar staff will have final say on drop location. Toemar is not responsible for any property damage if permission is granted to deliver on the private property.
- A 25% re-stocking charge is applied to all returned products that are not damaged and/or defective.
- Orders that have been delivered and cancelled by customer are subject to a pick up charge of \$120 (local area price only, prices subject to increase in accordance to distance) plus the applicable re-stocking fees. Skids are required to be in original condition, if skid(s) require re-packing then additional fees will apply.
- Bin rentals are charged for soil/dirt only. Extra fees are applied to additional materials added to the soil/dirt bin.
- Bin rentals used for renovation waste (such as wood or drywall) are charged according to weight. A \$199 flat rate fee will be applied to the bin. Bin contents will be charged at \$99 per metric ton. A credit card must be given.

# Bagged Products

## SOILS & MULCH

	SIZE*	PRICE
3-WAY MIX	30 L	\$3.39
TOP SOIL	30 L	\$3.39
BLACK EARTH	30 L	\$3.39
POTTING SOIL	30 L	\$5
SHEEP / CATTLE MANURE COMPOST	30 L	\$5
100% REAL CATTLE MANURE	30 L	\$5
PEAT MOSS	2.2 ft <sup>3</sup>	\$6
PEAT MOSS	3.8 ft <sup>3</sup>	\$9
CEDAR / HEMP MULCH	2 ft <sup>3</sup>	\$7.99
BARK NUGGETS	2 ft <sup>3</sup>	\$7.99
RED CEDAR MULCH	3 ft <sup>3</sup>	\$7.99
BLACK CEDAR MULCH	3 ft <sup>3</sup>	\$7.99
LANDSCAPE FABRIC	3' x 25'	\$14
LANDSCAPE FABRIC	3' x 50'	\$18
LANDSCAPE FABRIC	4' x 50'	\$23
LANDSCAPE FABRIC	4' x 100'	\$39
LANDSCAPE FABRIC	4' x 150'	\$56

## DECORATIVE ROCK

WHITE MARBLE (1" OR ¾")	20 kg	\$6
RIVER ROCK 1", 1-3"	20 kg	\$6
RIVER ROCK 4-8"	30 kg	\$12
RED BRICK	30 L	\$7
GOLD PEBBLE	18 kg	\$12

## GRASS SEED

QUICK SUN / SHADE	1 kg	\$10
QUICK SUN / SHADE	2 kg	\$18
QUICK SUN / SHADE	5 lb	\$40
STARTER FERTILIZER	2 kg	\$10

\*Note: Bag sizes may change without notice

## FIREWOOD\*\*

	SIZE*	PRICE
FIREWOOD BAGS	0.75 ft <sup>2</sup>	\$10
KINDLING BAGS	0.3 ft <sup>3</sup>	\$6
¼ FACE CORD	8 ft <sup>3</sup>	\$55
½ FACE CORD	16 ft <sup>3</sup>	\$90
1 FACE CORD	32 ft <sup>3</sup>	\$140*

## AGGREGATES

LIMESTONE SCREENINGS	30 L	\$4.25
CRUSH RUN	30 L	\$5
¾ CLEAR GRAVEL	30 L	\$4.25
COARSE SAND	30 L	\$5
FINE SAND	30 L	\$5
⅜ PEA GRAVEL	30 L	\$5.50
HPB	30 L	\$5.50

## INTERLOCKING SAND

JOINTING SAND	20 kg	\$6
POLYMERIC SAND BROWN	22 kg	\$22
POLYMERIC SAND GREY	22 kg	\$22
POLYMERIC SAND BLACK	22 kg	\$30

## CONCRETE / CEMENT

STONE MIX	30 kg	\$5.80
SAND MIX	30 kg	\$6.89
PORTLAND	30 kg	\$16.00
MORTAR MIX	40 kg	\$6.99
MORTAR TYPE S	33 kg	\$14.50
MODIFIED MORTAR	20 kg	\$25

\*\*Local firewood delivery \$60

	VEGGIE/ OVERSEED SOIL	TOP SOIL	CATTLE MANURE	BROWN MULCH	RED/BLACK MULCH	LIMESTONE SCREENING	CRUSH RUN GRAVEL	SAND/ GRAVEL	HPB/PEA GRAVEL	1-3" POTATO STONE	1-3" RIVER STONE	3-5" RIVER STONE
1 CU. YD.	\$108	\$82	\$108	\$103	\$114	\$97	\$99	\$108	\$107	\$139	\$178	\$185
2 CU. YD.	\$156	\$104	\$156	\$146	\$168	\$134	\$138	\$156	\$154	\$218	\$296	\$310
3 CU. YD.	\$204	\$126	\$204	\$189	\$222	\$171	\$177	\$204	\$201	\$297	\$414	\$435
4 CU. YD.	\$252	\$148	\$252	\$232	\$276	\$208	\$216	\$252	\$248	\$376	\$532	\$560
5 CU. YD.	\$300	\$170	\$300	\$275	\$330	\$245	\$255	\$300	\$295	\$455	\$650	\$685
6 CU. YD.	\$348	\$192	\$348	\$318	\$384	\$282	\$294	\$348	\$342	\$534	\$768	\$810
7 CU. YD.	\$396	\$214	\$396	\$361	\$438	\$319	\$333	\$396	\$389	\$613	\$886	\$935
8 CU. YD.	\$444	\$236	\$444	\$404	\$492	\$356	\$372	\$444	\$436	\$692	\$1004	\$1060

\*IMPORTANT NOTE: Bulk products are delivered loose and NOT in a bag. If you want a bulk product in bag, please visit gardenbag.ca or speak to our staff for more details

## PRO TIP

### VEGGIE SOIL

is a clay-free mixture of peat loam, sand loam, compost and manure

Excellent for:

- New Flower and Vegetable Beds
- Top Dressing Existing Gardens
- Mixing in Composter

### TOP SOIL

is best used for grading or filling uneven ground

### MULCH

is an organic ground cover, to beautify and protect root systems from frost and drought.

### LIMESTONE SCREENINGS

is most commonly used as base for interlocking pavers and patio stones

## QUICK METHOD TO CALCULATE HOW MUCH YOU NEED, BY THE YARD

- Works with Topsoil, Sand, Gravel, etc.
- Allow 10% for settling

Using tape measure, multiply...

$$\text{LENGTH (FEET)} \times \text{WIDTH (FEET)} \times \text{DEPTH (INCHES)} = \text{_____} \div 300 = \text{_____ YARDS}$$

- One Cubic Yard is 7 wheelbarrow (4 cu.ft.) or 27 bags (1 cubic foot or 28 litres)

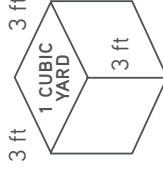

# BIN RENTAL SIZES

4 yard \$249 8 yard \$315 12 yard \$415 25 yard\* \$199

Rental term: 4 days. \$40 for every additional day. \*Renovation waste only:

Base plus \$99 per ton (2 ton minimum)



## MY WORKSHEET

Before you make your order, here's a handy checklist to make sure you have all the information you need:

- 
- 
- 
- 
- 
- 
- 
- 



/toemargardensupplies



/toemargarden



/toemar



**Toemar**<sup>1979</sup>  
GARDEN SUPPLIES • FIREWOOD

1005 Eglinton Ave. W., Mississauga, ON L5V 1R7  
905-826-3821

[www.toemar.ca](http://www.toemar.ca)